

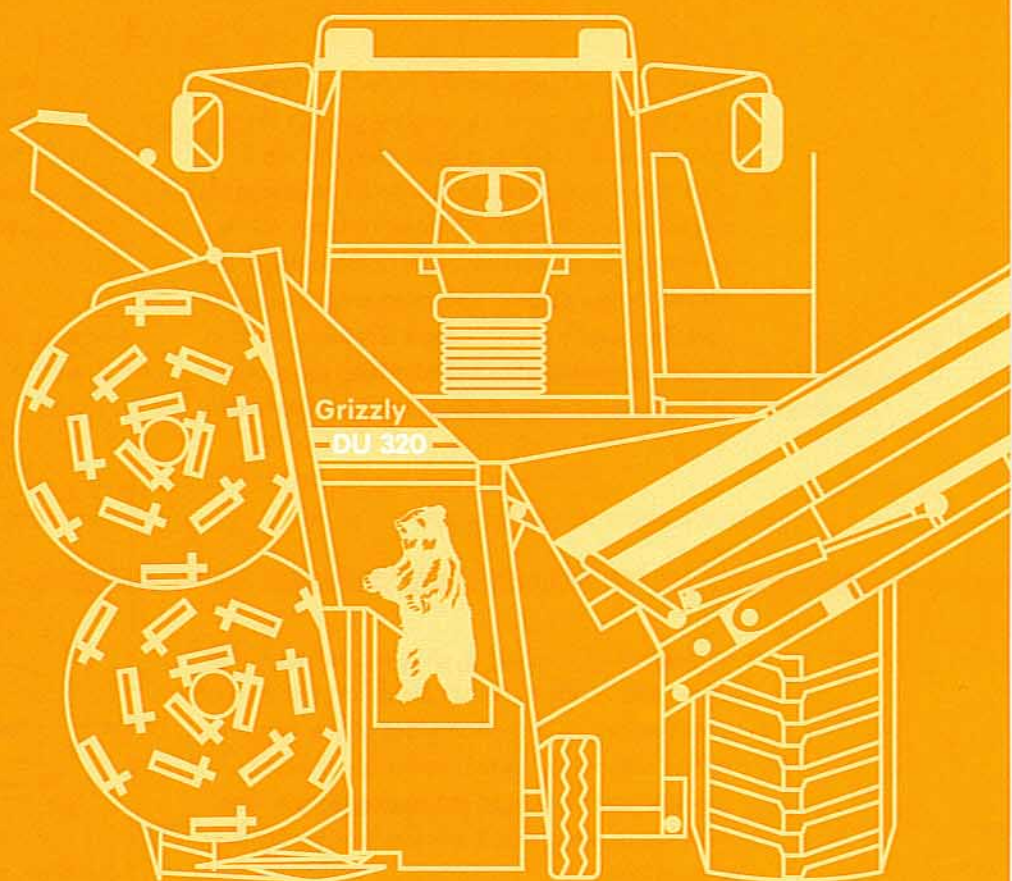

Doppstadt

DU 320 Grizzly
Windrow Turner



Doppstadt

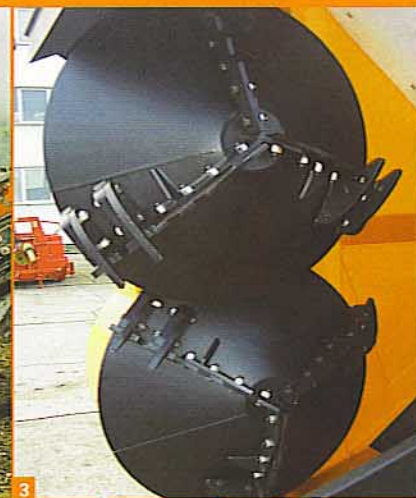

>>> An independent windrow turner...

...the DU 320 is independent of the windrow shape. It can achieve up to 1000 m³/h. The special features of this windrow turner are mobility, short setup times and the flexible use on site. The independent tractor unit has a 97 % motor output at the PTO. The comfortable cabin is equipped with a turning seat. The tractor can drive forwards and reverse. The wear-resistant tools are easily replaceable. By using different forms of tools, the windrow turner is adjustable to various requirements.

- >> 1 Thanks to the hydraulically foldable elements for road traffic* and transport e.g. with low loader, the DU 320 is quickly ready to work.
- >> 2 The turning unit is mounted on an independent tractor unit with high PTO output (appr. 97 % of the motor power) by three-point linkage, the milling cutter discs at the head enter the windrow. The forestry tyres ensure a reliable traction.
- >> 3 Wear-resistant blade-shaped milling tools on the discs are easily accessible and quickly replaceable.

*) option

- >> 4 With a long-grass wedge, even cot material can easily be processed.
- >> 4 The comfortable cabin with air-conditioning and optional protected aeration* offers an ergonomic working place and an optimum panoramic view.



Working principle: With its milling cutter discs, the windrow turner slices off the side of the windrow. It is independent of the windrow shape and height. A fast-running conveyor throws the material to the opposite side. The new windrow is exactly determined by the discharge control.

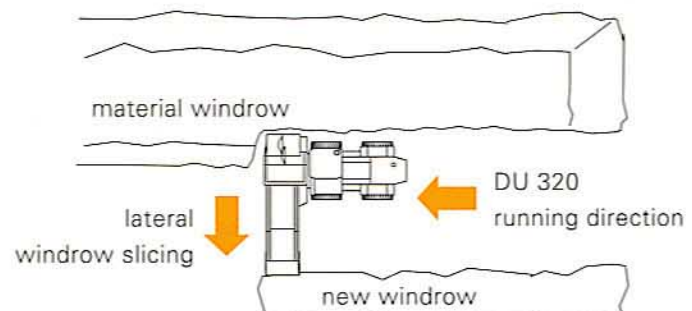



>> Rotation and oxygenation, in particular of compost stacks, contaminated soil and in mechanical-biological treatment systems

>> Vehicle with implement trailer

>> ...with chopper

>> ... maize chopper

>> ... for compost rotation



Turning and processing of compost windrows, contaminated soils, material windrows of shredded residual / organic waste, long grass windrows – independent of the windrow shape...

Building and processing of independent windrow shapes with large compost centre, throughput up to more than 1,000 m³/h.

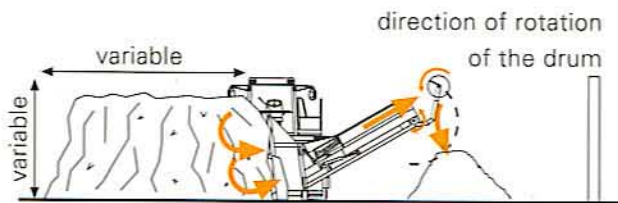

Individual, exact building of the windrow thanks to the variable discharge by hydraulically controlled discharge hood/drum*:

1. step: downwards deflection, basis building

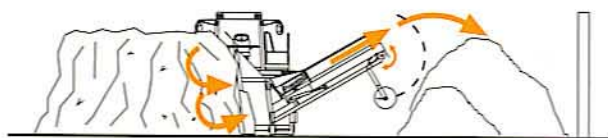

2. step: normal. lateral windrow building

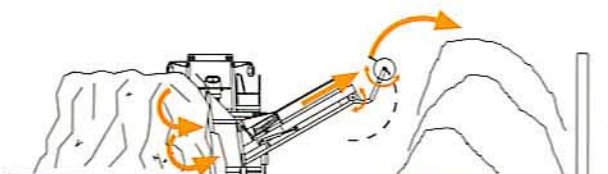

3. step: upwards deflection(*), top section building

DU 320 Grizzly

Technical Data (dimensions in mm)

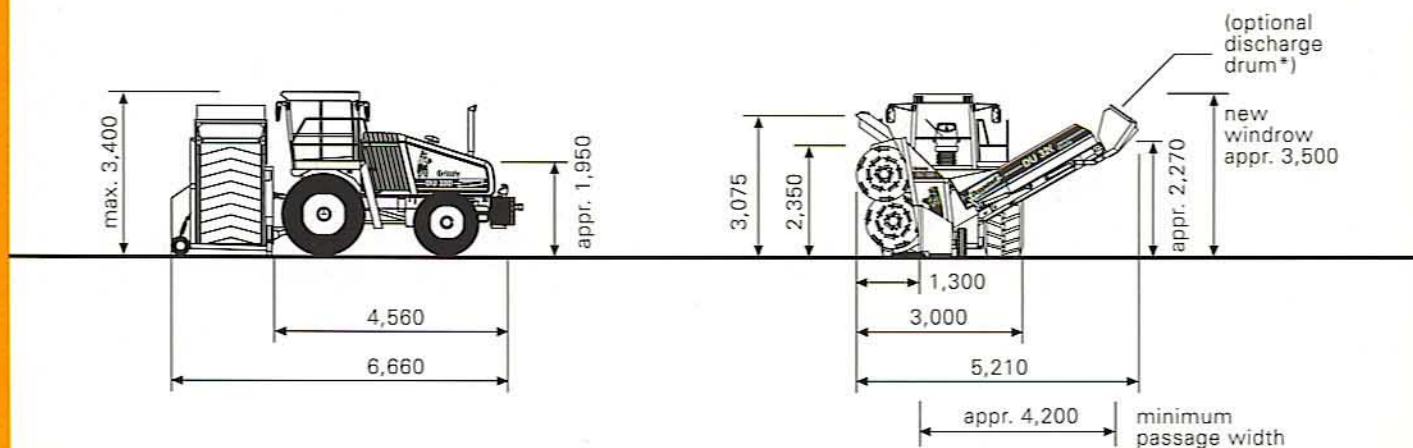

Max. total weight	appr. 5,500 kg (turning unit)
Description	Windrow turner, independent of the windrow size and shape, mounted on a tractor unit with forward and reverse gear, the side of the material windrow is sliced off and a new windrow is built on the opposite side
Type	DAF, PF 235 M
Power	235 kW (320 hp), 2,300 rpm
Exhaust level	EUROMOT 2
Tools	6 teeth, 3 short blades
Cubic capacity	9,200 cm ³
Max. Torque	1,275 Nm
Fuel tank	430 l
Milling cutter discs	2 pc. 1,160 mm diametre each
Speed / Tools	appr. 220 rpm / 3 long blades
Conveyor	vulcanized profiled belt, bars
Width	1,200 mm
Belt speed	appr. 6.6 m/s
New windrow height	up to appr. 3,3 m, with discharge drum* max 3,5 m (controlled by hydraulic system of the vehicle)
Throughput	up to 1,000 m ³ /h, depends on the material
Drive	by the tractor unit
Speed	max. 30 km/h
Mounting	3three-point linkage, front and rear
PTOs	228 kW (310 hp) max. at 1,000 rpm
Equipment	comfortable cabin with optimum view, air conditioning, reversing facility with comfortable turning seat, multifunction-lever for drive and control of the turningunit and the tractor unit, forestry tyres
Options (*)	discharge drum, protected aeration, damping facility, trailer for road traffic

Doppstadt Calbe GmbH
 Barbyer Chaussee 3, 39240 Calbe/Saale, Germany
 phone: (+49) 3 92 91 / 55 - 270
 fax: (+49) 3 92 91 / 55 - 358
 info@doppstadt.com, www.doppstadt.com

May 2003, specifications subject to technical alterations.
 The specifications are approximate, illustrations and descriptions might include options that are not part of the standard equipment.

Doppstadt